

■ Features

- Simple Drive Requirement
- Small Package Outline
- Surface Mount Device

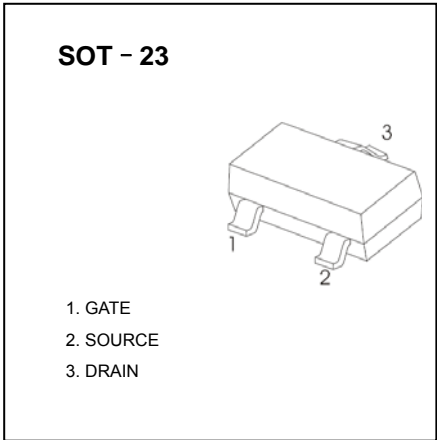

MARKING

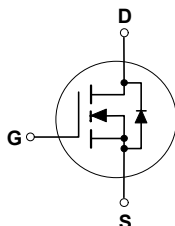
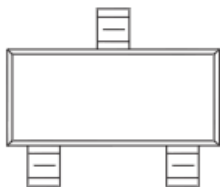

■ Absolute Maximum Ratings Ta = 25°C

Parameter	Symbol	Rating	Unit
Drain-Source Voltage	V _{DS}	60	V
Gate-Source Voltage	V _{GS}	±20	V
Continuous Drain Current	I _D	T _A =25°C	A
		T _A =70°C	
Pulsed Drain Current *	I _{DM}	10	
Power Dissipation	P _D	1.38	W
Linear Derating Factor		0.01	W/°C
Thermal Resistance Junction-to-ambient	R _{thJa}	90	°C/W
Junction and Storage Temperature Range	T _J , T _{STG}	-55 to 150	°C

* 2. Pulse width ≤ 300us , duty cycle ≤ 2%.

■ Electrical Characteristics Ta = 25°C

Parameter	Symbol	Testconditons	Min	Typ	Max	Unit
Drain-Source Breakdown Voltage	V _{DSS}	I _D =250μA, V _{GS} =0V	60			V
Zero Gate Voltage Drain Current	I _{DSS}	V _{DS} =60V, V _{GS} =0V			10	μA
		V _{DS} =48, V _{GS} =0V, T _J =70°C			25	
Gate-Body leakage current	I _{GSS}	V _{DS} =0V, V _{GS} =±20V			±100	nA
Gate Threshold Voltage	V _{GS(th)}	V _{DS} =V _{GS} I _D =-250μA	1		3	V
Static Drain-Source On-Resistance	R _{DS(on)}	V _{GS} =10V, I _D =3A			90	mΩ
		V _{GS} =4.5V, I _D =2A			120	
Forward Transconductance	g _{FS}	V _{DS} =5V, I _D =3A		5		S
Input Capacitance	C _{iss}	V _{GS} =0V, V _{DS} =25V, f=1MHz		490	780	pF
Output Capacitance	C _{oss}			55		
Reverse Transfer Capacitance	C _{rss}			40		
Total Gate Charge	Q _g	V _{DS} =48V, I _D =3A, V _{GS} =4.5V		6	10	nC
Gate Source Charge	Q _{gs}			1.6		
Gate Drain Charge	Q _{gd}			3		
Turn-On DelayTime	t _{D(on)}	V _{GS} =10V, V _{DS} =30V, I _D =1A RD=30Ω, R _{GEN} =3.3Ω		6		ns
Turn-On Rise Time	t _r			5		
Turn-Off DelayTime	t _{D(off)}			16		
Turn-Off Fall Time	t _f			3		
Body Diode Reverse Recovery Time	t _{rr}	I _S =3A, dI/dt=100A/μs		25		
Body Diode Reverse Recovery Charge	Q _{rr}	I _S =3A, dI/dt=100A/μs		26		nC
Diode Forward Voltage	V _{SD}	I _S =1.2A, V _{GS} =0V			1.2	V

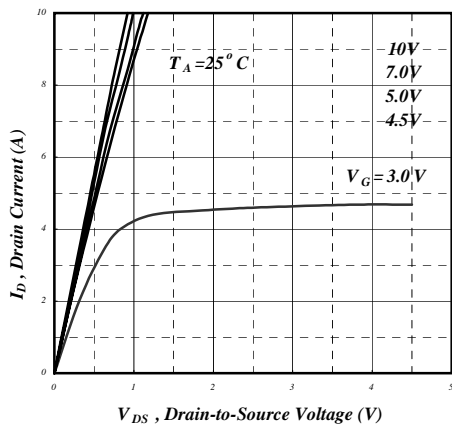

Fig 1. Typical Output Characteristics

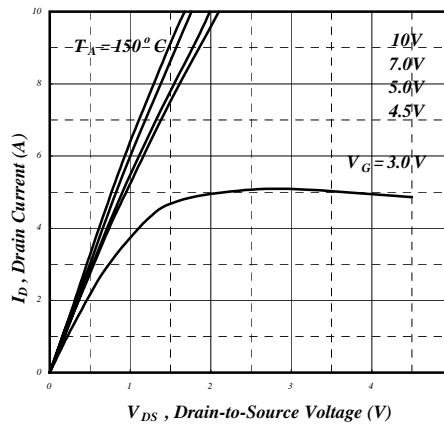

Fig 2. Typical Output Characteristics

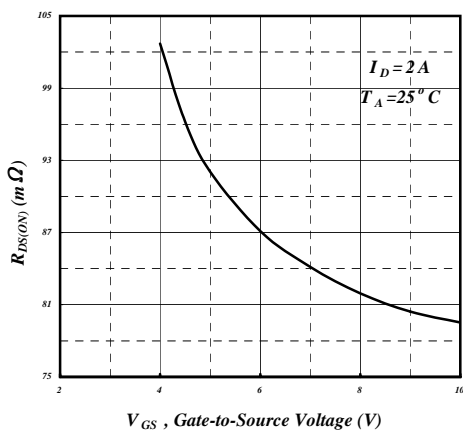

Fig 3. On-Resistance v.s. Gate Voltage

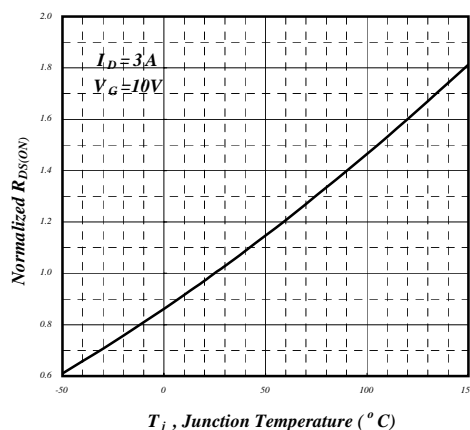

Fig 4. Normalized On-Resistance v.s. Junction Temperature

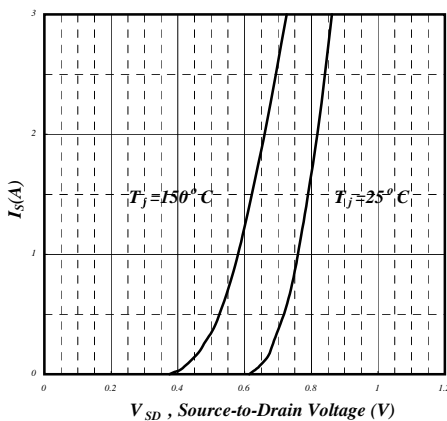

Fig 5. Forward Characteristic of Reverse Diode

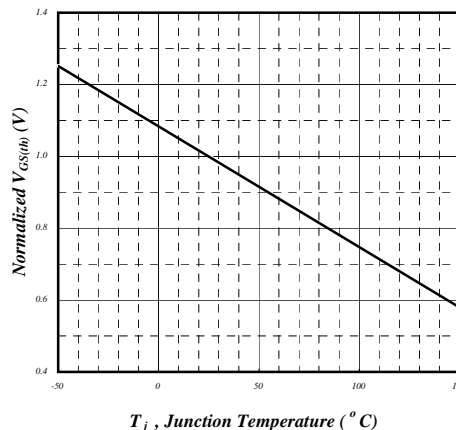

Fig 6. Gate Threshold Voltage v.s. Junction Temperature

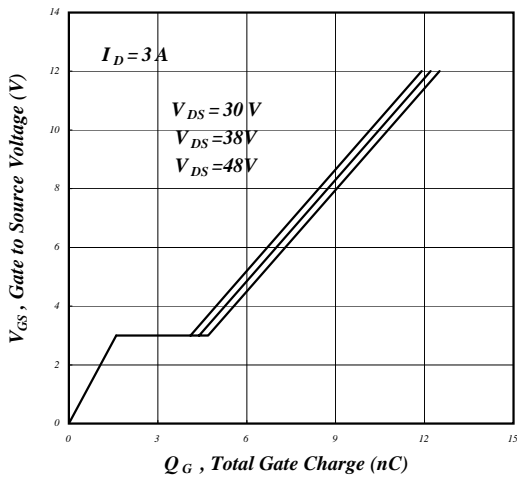

Fig 7. Gate Charge Characteristics

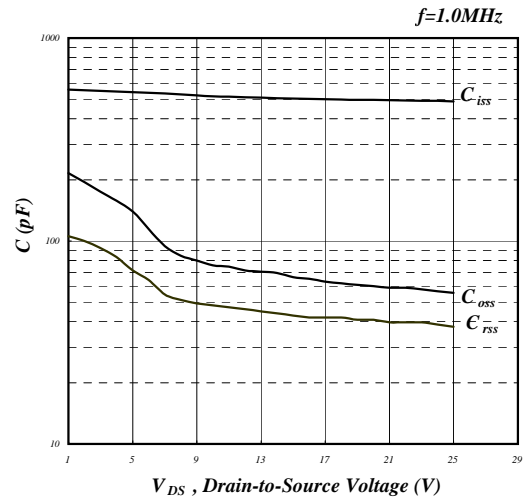

Fig 8. Typical Capacitance Characteristics

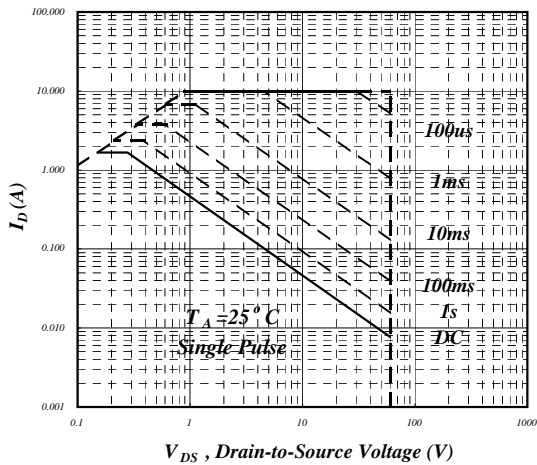

Fig 9. Maximum Safe Operating Area

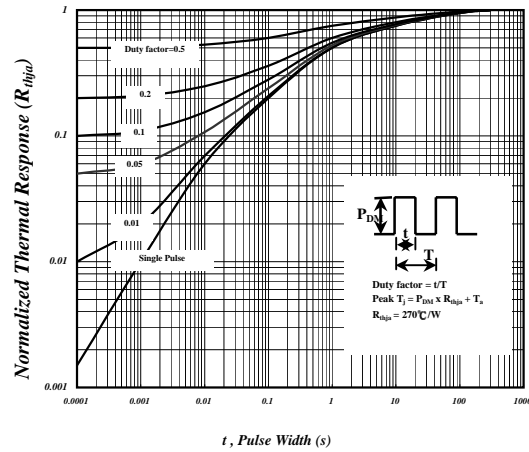
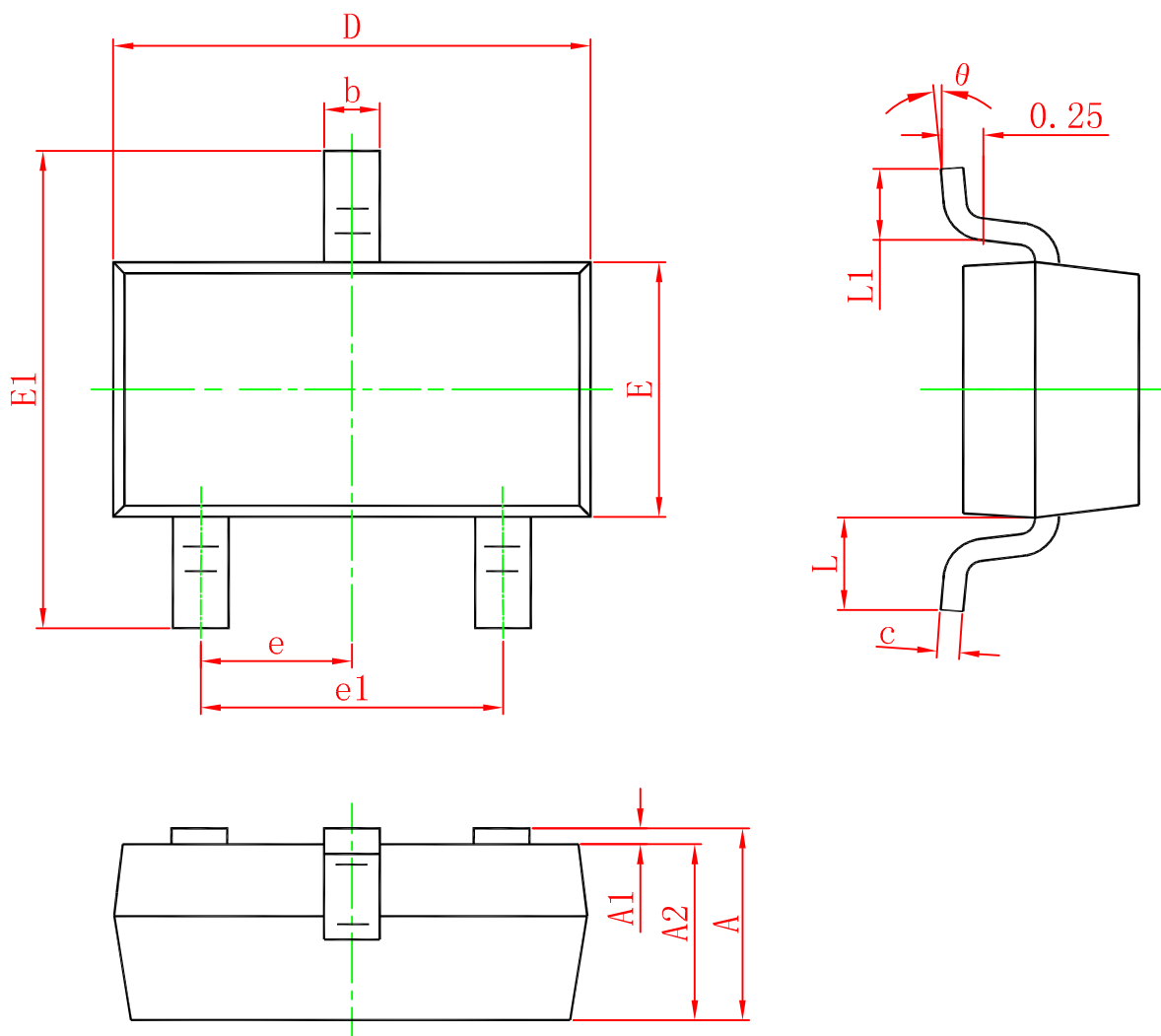

Fig 10. Effective Transient Thermal Impedance

SOT-23 PACKAGE OUTLINE DIMENSIONS



Symbol	Dimensions In Millimeters		Dimensions In Inches	
	Min.	Max.	Min.	Max.
A	0.900	1.150	0.035	0.045
A1	0.000	0.100	0.000	0.004
A2	0.900	1.050	0.035	0.041
b	0.300	0.500	0.012	0.020
c	0.080	0.150	0.003	0.006
D	2.800	3.000	0.110	0.118
E	1.200	1.400	0.047	0.055
E1	2.250	2.550	0.089	0.100
e	0.950 TYP.		0.037 TYP.	
e1	1.800	2.000	0.071	0.079
L	0.550 REF.		0.022 REF.	
L1	0.300	0.500	0.012	0.020
θ	0°	8°	0°	8°