

## P-Channel Enhancement Mode MOSFET Feature

- -60V/-0.13A,  $R_{DS(ON)} = \leq 6 \Omega$  (MAX) @ $V_{GS} = -10V$
- Super High dense cell design for extremely low  $R_{DS(ON)}$
- Reliable and Rugged
- SOT-23 for Surface Mount Package
- ESD protection

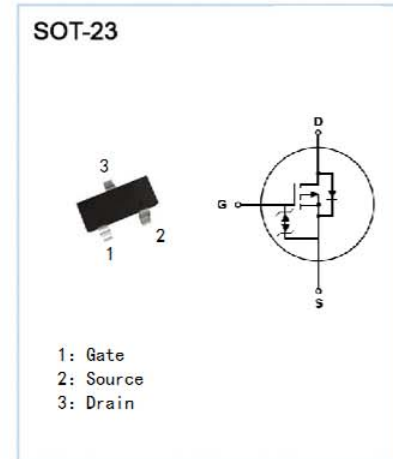

## Applications

- Power Management  
Portable Equipment and Battery Powered Systems.

## Absolute Maximum Ratings

$T_A = 25^\circ\text{C}$  Unless Otherwise noted

| Parameter                | Symbol   | Limit    | Units |
|--------------------------|----------|----------|-------|
| Drain-Source Voltage     | $V_{DS}$ | -60      | V     |
| Gate-Source Voltage      | $V_{GS}$ | $\pm 20$ | V     |
| Drain Current-Continuous | $I_D$    | -0.13    | A     |

## Electrical Characteristics

$T_A = 25^\circ\text{C}$  Unless Otherwise noted

| Parameter   | Symbol       | Test Conditions                  | Min  | Typ. | Max  | Units    |
|---|--------------|----------------------------------|------|------|------|----------|
| <b>Off Characteristics</b>                                    |              |                                  |      |      |      |          |
| Drain to Source Breakdown Voltage                             | BVDSS        | $V_{GS} = 0V, I_D = -250\mu A$   | -60  | -    | -    | V        |
| Zero-Gate Voltage Drain Current                               | $I_{DSS}$    | $V_{DS} = -50V, V_{GS} = 0V$     | -    | -    | -1   | $\mu A$  |
| Gate Body Leakage Current, Forward                            | $I_{GSSF}$   | $V_{GS} = 20V, V_{DS} = 0V$      | -    | -    | 10   | $\mu A$  |
| Gate Body Leakage Current, Reverse                            | $I_{GSSR}$   | $V_{GS} = -20V, V_{DS} = 0V$     | -    | -    | -10  | $\mu A$  |
| <b>On Characteristics</b>                                     |              |                                  |      |      |      |          |
| Gate Threshold Voltage  | $V_{GS(th)}$ | $V_{GS} = V_{DS}, I_D = -1mA$    | -0.8 | -1.5 | -2.5 | V        |
| Static Drain-sourceOn-Resistance                              | $R_{DS(ON)}$ | $V_{GS} = -4.5V, I_{DS} = -0.2A$ | -    | 4    | 7    | $\Omega$ |
| <b>Drain-Source Diode Characteristics and Maximum Ratings</b> |              |                                  |      |      |      |          |
| Drain-Source Diode Forward Voltage                            | VSD          | $I_{SD} = 0.5A, V_{GS} = 0V$     |      |      | -1.3 | V        |

| DYNAMIC PARAMETERS           |         |  |     |  |    |
|------------------------------|---------|--|-----|--|----|
| Input Capacitance            | Ciss    | VGS=0V, VDS=-5V, f=1MHz                | 30  |  | pF |
| Output Capacitance           | Coss    |  | 10  |  | pF |
| Reverse Transfer Capacitance | Crss    |  | 5   |  | pF |
| SWITCHING PARAMETERS         |         |  |     |  |    |
| Turn-On Delay Time           | ID(on)  | VGS=-10V, VDS=-15V, ID=-0.25A, RL=50 Ω | 2.5 |  | ns |
| Turn-On Rise Time            | tr      |  | 1.0 |  | ns |
| Turn-Off Delay Time          | ID(off) |  | 16  |  | ns |
| Turn-Off Fall Time           | tr      |  | 8   |  | ns |

## Typical Characteristics

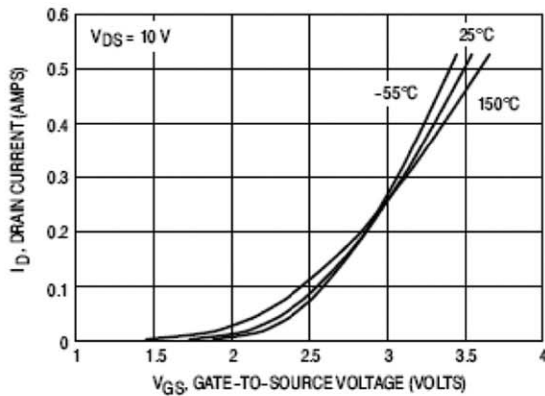

Figure 1. Transfer Characteristics

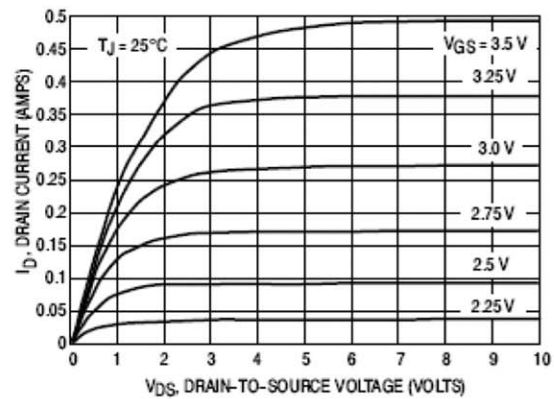

Figure 2. On-Region Characteristics

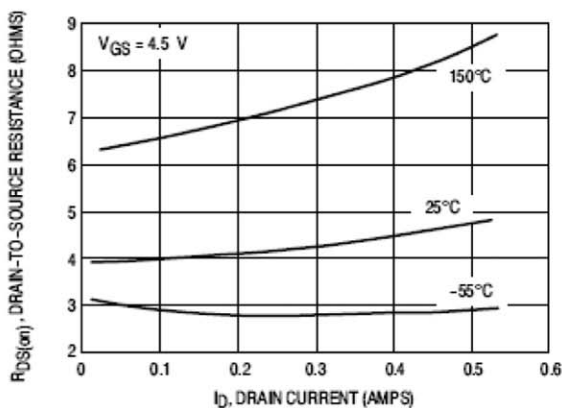

Figure 3. On-Resistance versus Drain Current

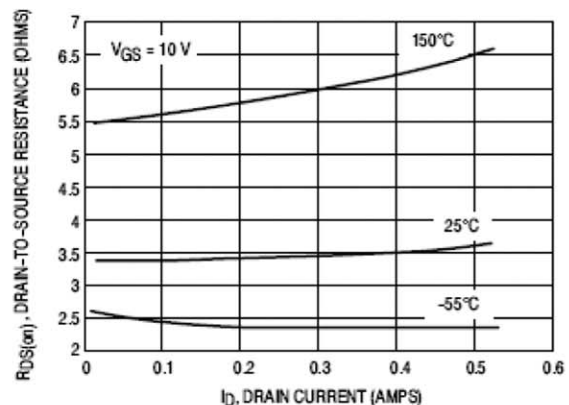

Figure 4. On-Resistance versus Drain Current

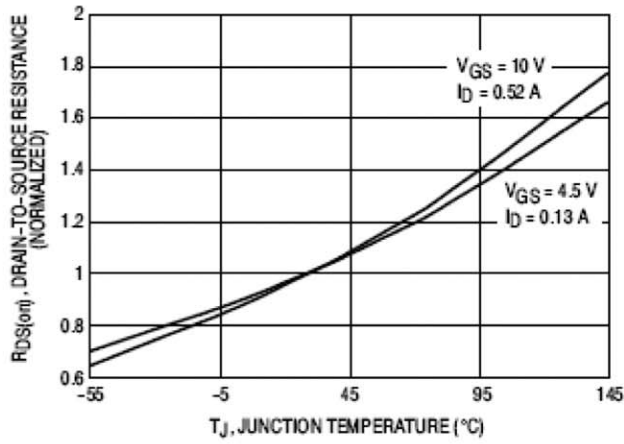

Figure 5. On-Resistance Variation with Temperature

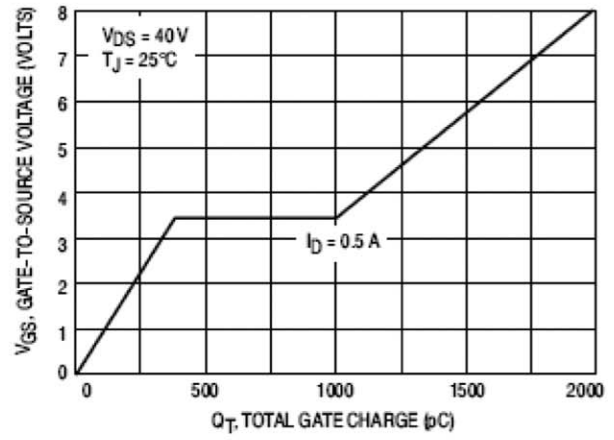

Figure 6. Gate Charge

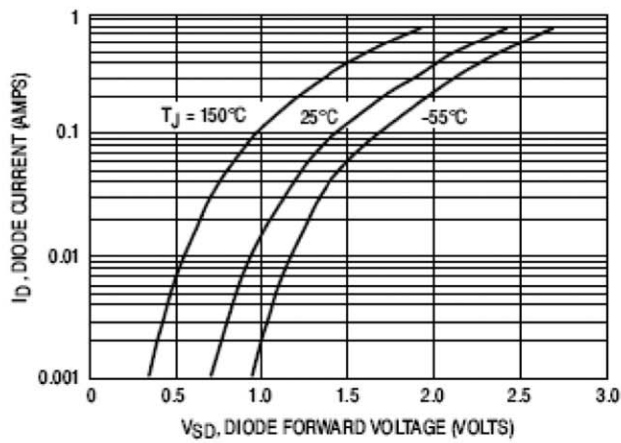

Figure 7. Body Diode Forward Voltage

## SOT-23 Package Outline Dimensions (UNIT: mm)

