

UMW SI2300A N-Channel 20-V(D-S) MOSFET

$V_{(BR)DSS}$	$R_{DS(on)MAX}$	I_D
20V	25mΩ@4.5V	6A
	34.5mΩ@2.5V	

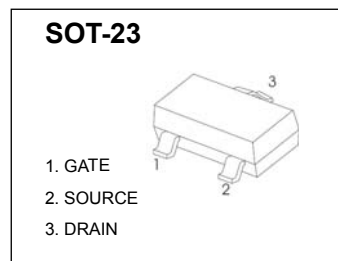

FEATURE

- TrenchFET Power MOSFET

APPLICATION

- Load Switch for Portable Devices
- DC/DC Converter

MARKING



Equivalent Circuit

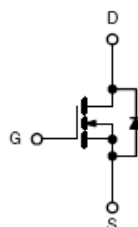

Maximum ratings ($T_a=25^{\circ}C$ unless otherwise noted)

Parameter	Symbol	Value	Unit
Drain-Source Voltage	V_{DS}	20	V
Gate-Source Voltage	V_{GS}	±12	
Continuous Drain Current	I_D	6	A
Continuous Source-Drain Current(Diode Conduction)	I_S	0.6	
Power Dissipation	P_D		W
Thermal Resistance from Junction to Ambient ($t \leq 5s$)	$R_{\theta JA}$	312.5	$^{\circ}C/W$
Operating Junction	T_J	150	$^{\circ}C$
Storage Temperature	T_{STG}	-55 ~ +150	

$T_a=25\text{ }^\circ\text{C}$ unless otherwise specified

Parameter	Symbol	Test Condition	Min	Typ	Max	Units
Static						
Drain-source breakdown voltage	$V_{(BR)DSS}$	$V_{GS} = 0V, I_D = 10\mu A$	20			V
Gate-threshold voltage	$V_{GS(th)}$	$V_{DS} = V_{GS}, I_D = 50\mu A$	0.40		1	
Gate-body leakage	I_{GSS}	$V_{DS} = 0V, V_{GS} = \pm 8V$			± 100	nA
Zero gate voltage drain current	I_{DSS}	$V_{DS} = 20V, V_{GS} = 0V$			1	μA
Drain-source on-resistance ^a	$r_{DS(on)}$	$V_{GS} = 4.5V, I_D = 6A$		0.021	0.025	Ω
		$V_{GS} = 2.5V, I_D = 5.2A$		0.028	0.034	
Forward transconductance ^a	g_{fs}	$V_{DS} = 5V, I_D = 3.6A$		8		S
Diode forward voltage	V_{SD}	$I_S = 0.94A, V_{GS} = 0V$		0.74	1.2	V
Dynamic						
Total gate charge	Q_g	$V_{DS} = 10V, V_{GS} = 4.5V, I_D = 3.6A$		7.7	10	nC
Gate-source charge	Q_{gs}			0.32		
Gate-drain charge	Q_{gd}			2.1		
Input capacitance ^b	C_{iss}	$V_{DS} = 10V, V_{GS} = 0V, f = 1MHz$		574		pF
Output capacitance ^b	C_{oss}			70		
Reverse transfer capacitance ^b	C_{rss}			60		
Switching^b						
Turn-on delay time	$t_{d(on)}$	$V_{DD} = 10V,$ $R_L = 5.5\Omega, I_D \approx 3.6A,$ $V_{GEN} = 4.5V, R_g = 6\Omega$		78.7		ns
Rise time	t_r			128		
Turn-off delay time	$t_{d(off)}$			453		
Fall time	t_f			80.9		

Notes :

- a. Pulse Test : Pulse width $\leq 300\mu s$, duty cycle $\leq 2\%$.
- b. These parameters have no way to verify.

Typical Characteristics (T_J =25°C Noted)

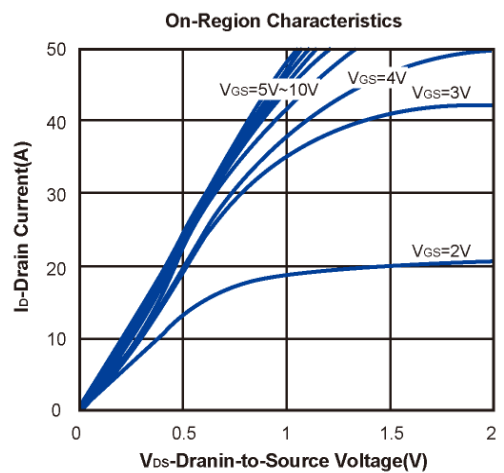
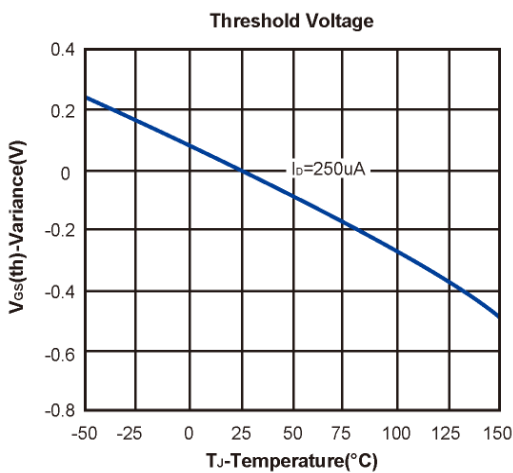
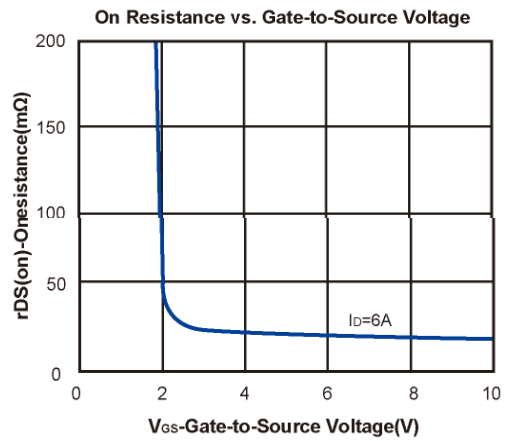
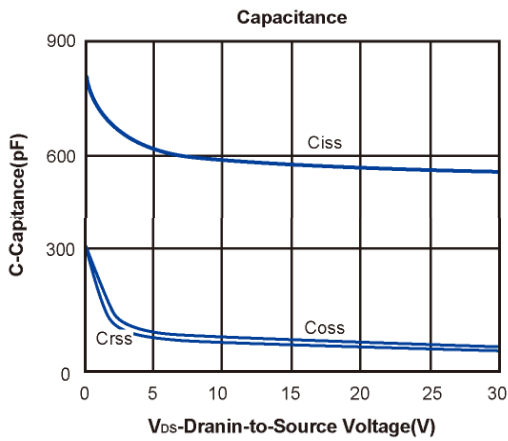
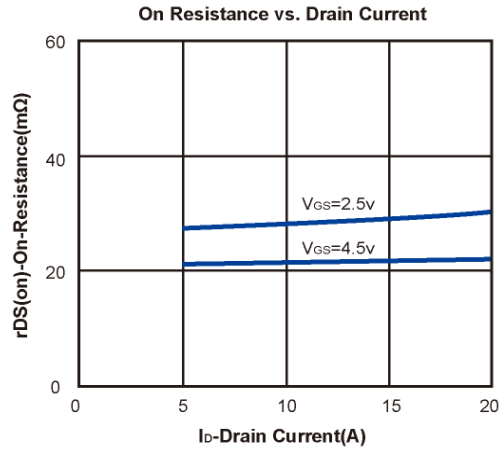
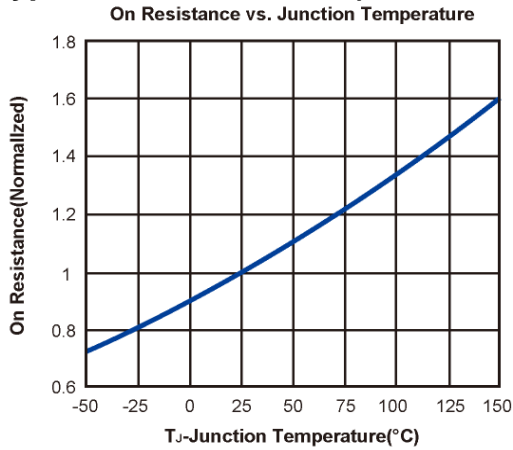

Typical Characteristics (T_J =25°C Noted)

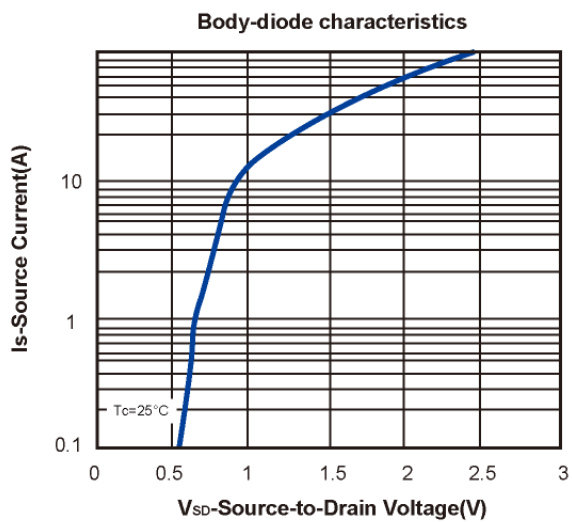
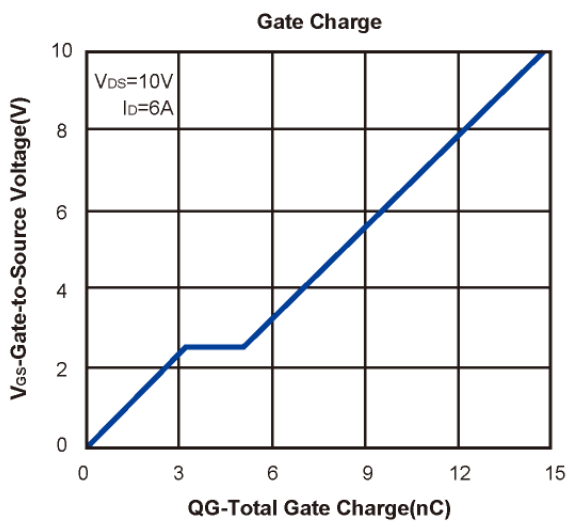

SOT-23 PACKAGE OUTLINE DIMENSIONS

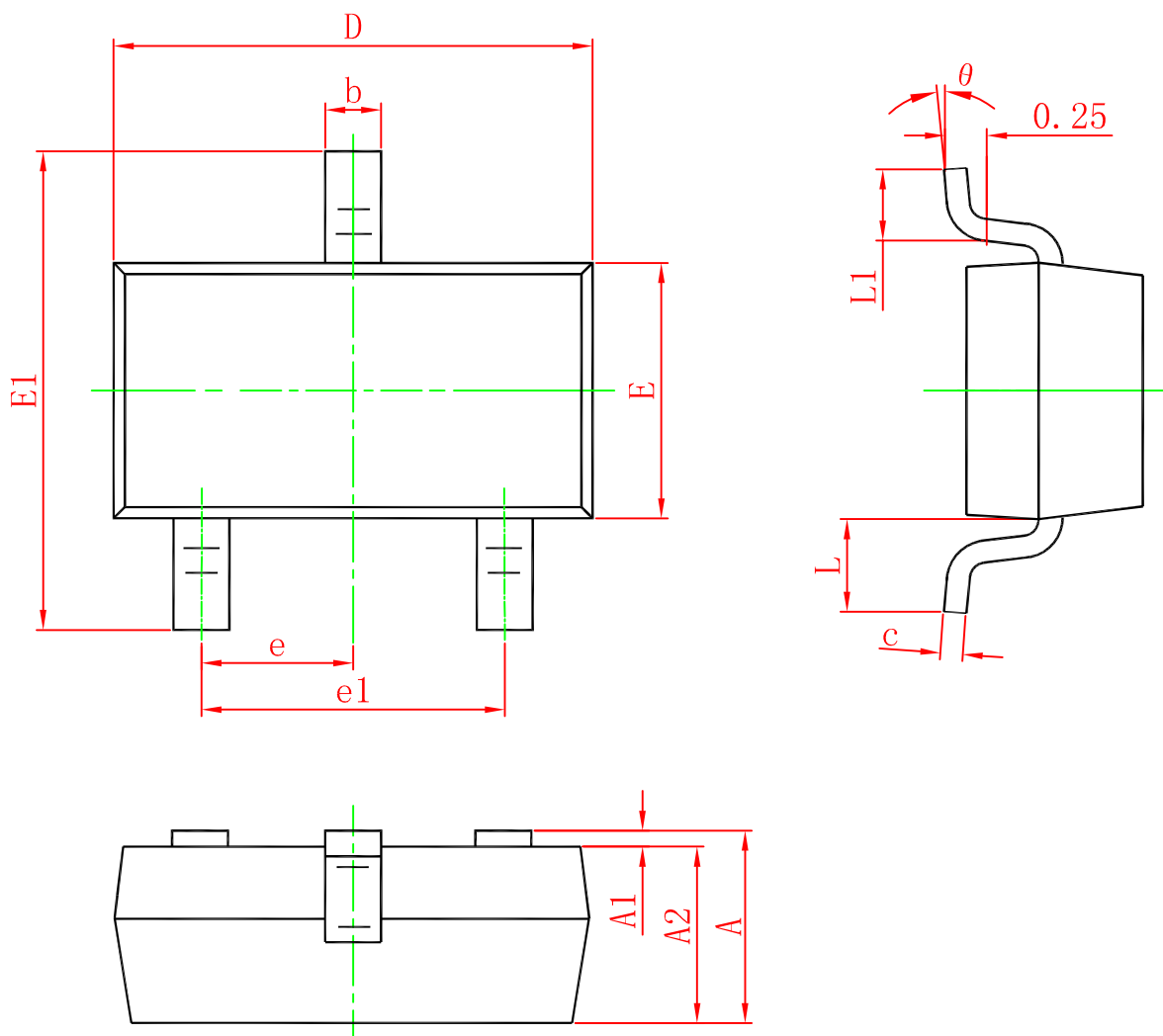

Symbol	Dimensions In Millimeters		Dimensions In Inches	
	Min.	Max.	Min.	Max.
A	0.900	1.150	0.035	0.045
A1	0.000	0.100	0.000	0.004
A2	0.900	1.050	0.035	0.041
b	0.300	0.500	0.012	0.020
c	0.080	0.150	0.003	0.006
D	2.800	3.000	0.110	0.118
E	1.200	1.400	0.047	0.055
E1	2.250	2.550	0.089	0.100
e	0.950 TYP.		0.037 TYP.	
e1	1.800	2.000	0.071	0.079
L	0.550 REF.		0.022 REF.	
L1	0.300	0.500	0.012	0.020
θ	0°	8°	0°	8°