

Features

- $V_{DS(V)} = 20V$
- $I_D = 6.5 A (V_{GS} = 4.5V)$
- $R_{DS(ON)} < 22m\Omega (V_{GS} = 4.5V)$
- $R_{DS(ON)} < 26m\Omega (V_{GS} = 2.5V)$
- $R_{DS(ON)} < 34m\Omega (V_{GS} = 1.8V)$

MARKING

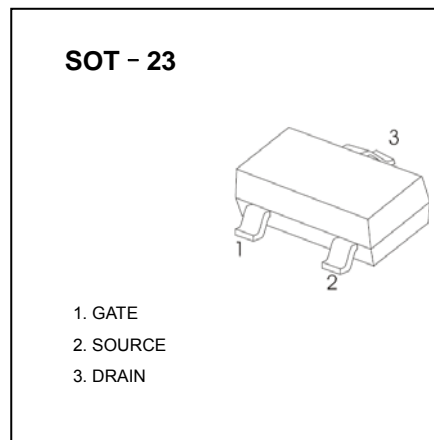
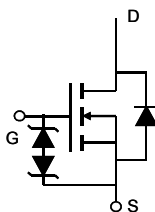
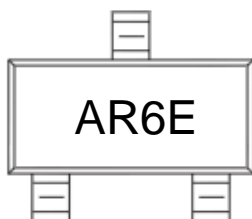

Absolute Maximum Ratings $T_a = 25^\circ C$

Parameter	Symbol	Rating	Unit	
Drain-Source Voltage	V_{DS}	20	V	
Gate-Source Voltage	V_{GS}	± 8		
Continuous Drain Current	I_D	$T_a=25^\circ C$	6.5	A
		$T_a=70^\circ C$	5.2	
Pulsed Drain Current	I_{DM}	30		
Power Dissipation	P_D	$T_a=25^\circ C$	1.4	W
		$T_a=70^\circ C$	0.9	
Thermal Resistance..Junction- to-Ambient $t \leq 10sec$ Steady State	R_{thJA}		90	$^\circ C/W$
			125	
Thermal Resistance..Junction-to-Foot	R_{thJF}	80		
Junction Temperature	T_J	150	$^\circ C$	
Storage Temperature Range	T_{stg}	-55 to 150		

■ Electrical Characteristics Ta = 25°C

Parameter	Symbol	Test Conditions	Min	Typ	Max	Unit
Drain-Source Breakdown Voltage	V _{DSS}	I _D =250μA, V _{GS} =0V	20			V
Zero Gate Voltage Drain Current	I _{DSS}	V _{DS} =20V, V _{GS} =0V			1	μA
		V _{DS} =20V, V _{GS} =0V, Ta=70°C			5	
Gate-Body Leakage Current	I _{GSS}	V _{DS} =0V, V _{GS} =±8V			±10	μA
Gate Threshold Voltage	V _{GS(th)}	V _{DS} =V _{GS} , I _D =250 μ A	0.4		1.1	V
On-State Drain Current	I _{D(on)}	V _{DS} =5 V, V _{GS} = 4.5 V	30			A
Static Drain-Source On-Resistance	R _{DS(on)}	V _{GS} =4.5V, I _D =6.5A			22	mΩ
		V _{GS} =4.5V, I _D =6.5A T _J =125°C			30	
		V _{GS} =2.5V, I _D =5.5A			26	
		V _{GS} =1.8V, I _D =5A			34	
Forward Transconductance	g _{FS}	V _{DS} =5V, I _D =6.5A		50		S
Input Capacitance	C _{iss}	V _{GS} =0V, V _{DS} =10V, f=1MHz		1295	1650	pF
Output Capacitance	C _{oss}			160		
Reverse Transfer Capacitance	C _{rss}			87		
Gate Resistance	R _g	V _{GS} =0V, V _{DS} =0V, f=1MHz		1.8		KΩ
Total Gate Charge	Q _g	V _{GS} =4.5V, V _{DS} =10V, I _D =6.5A		10		nC
Gate Source Charge	Q _{gs}			4.2		
Gate Drain Charge	Q _{gd}			2.6		
Turn-On DelayTime	t _{d(on)}	V _{DS} =10V, V _{GEN} =4.5V R _L =1.54Ω, R _G =3Ω		280		ns
Turn-On Rise Time	t _r			328		
Turn-Off DelayTime	t _{d(off)}			3.76		
Turn-Off Fall Time	t _f			2.24		
Body Diode Reverse Recovery Time	t _{rr}	I _F = 6.5A, di/dt= 100A/ μ s		31	41	nC
Body Diode Reverse Recovery Charg	Q _{rr}			6.8		
Maximum Body-Diode Continuous Current	I _s				2	A
Diode Forward Voltage	V _{SD}	I _s =1.0A, V _{GS} =0V		0.62	1	V

*1 Pulse test: PW ≤ 300us duty cycle ≤ 2%.

■ Typical Characteristics

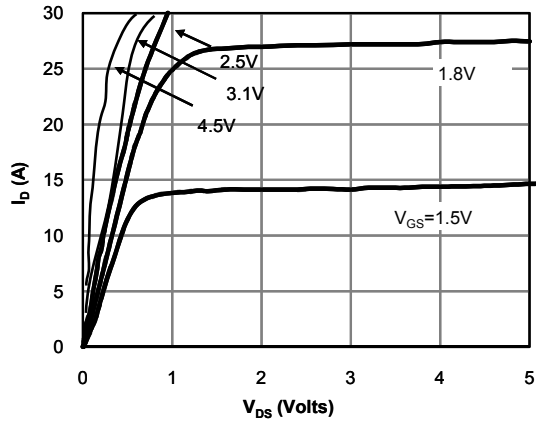

Fig 1: On-Region Characteristics (Note E)

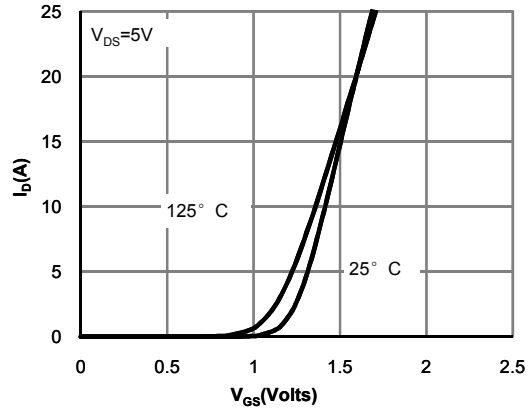

Figure 2: Transfer Characteristics (Note E)

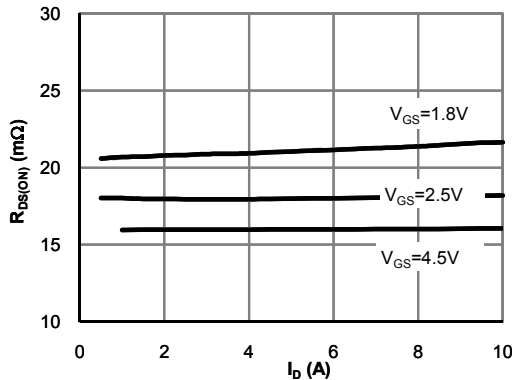

Figure 3: On-Resistance vs. Drain Current and Gate Voltage (Note E)

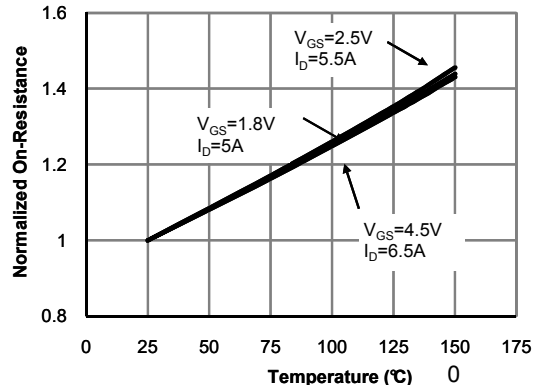

Figure 4: On-Resistance vs. Junction Temperature (Note E)

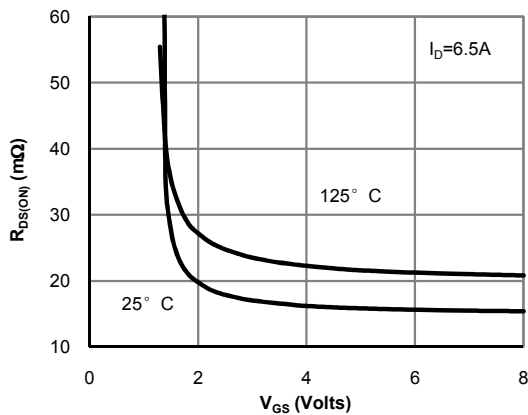

Figure 5: On-Resistance vs. Gate-Source Voltage (Note E)

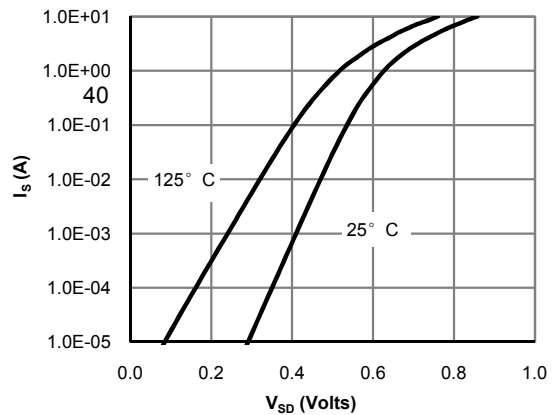

Figure 6: Body-Diode Characteristics (Note E)

■ Typical Characteristics

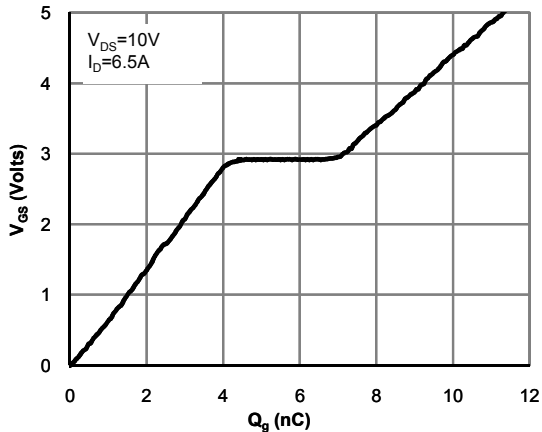

Figure 7: Gate-Charge Characteristics

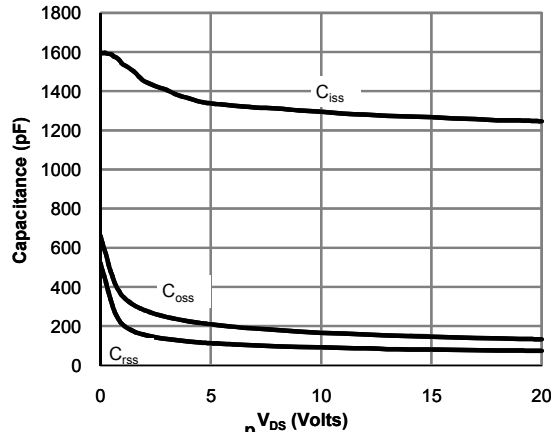

Figure 8: Capacitance Characteristics

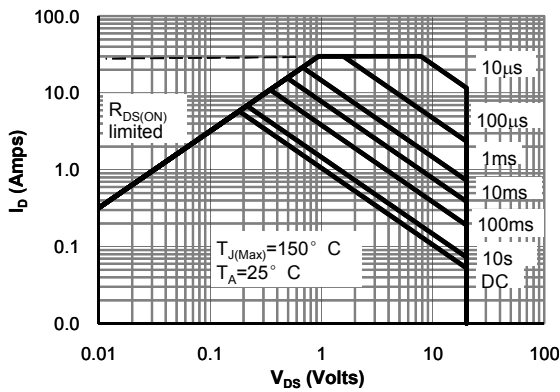

Figure 9: Maximum Forward Biased Safe Operating Area (Note F)

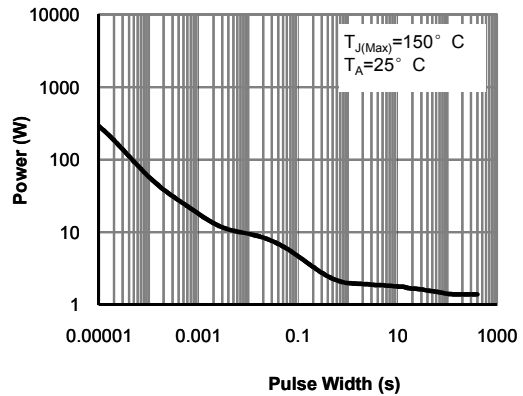

Figure 10: Single Pulse Power Rating Junction-to-Ambient (Note F)

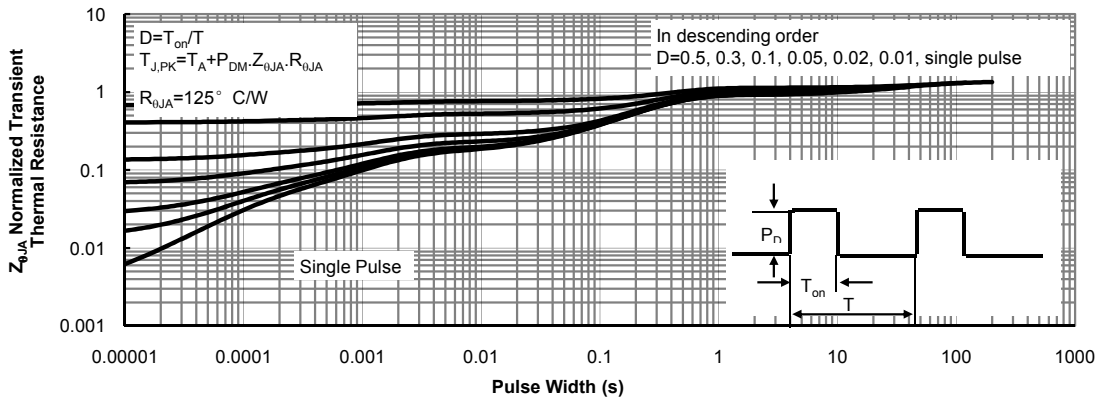
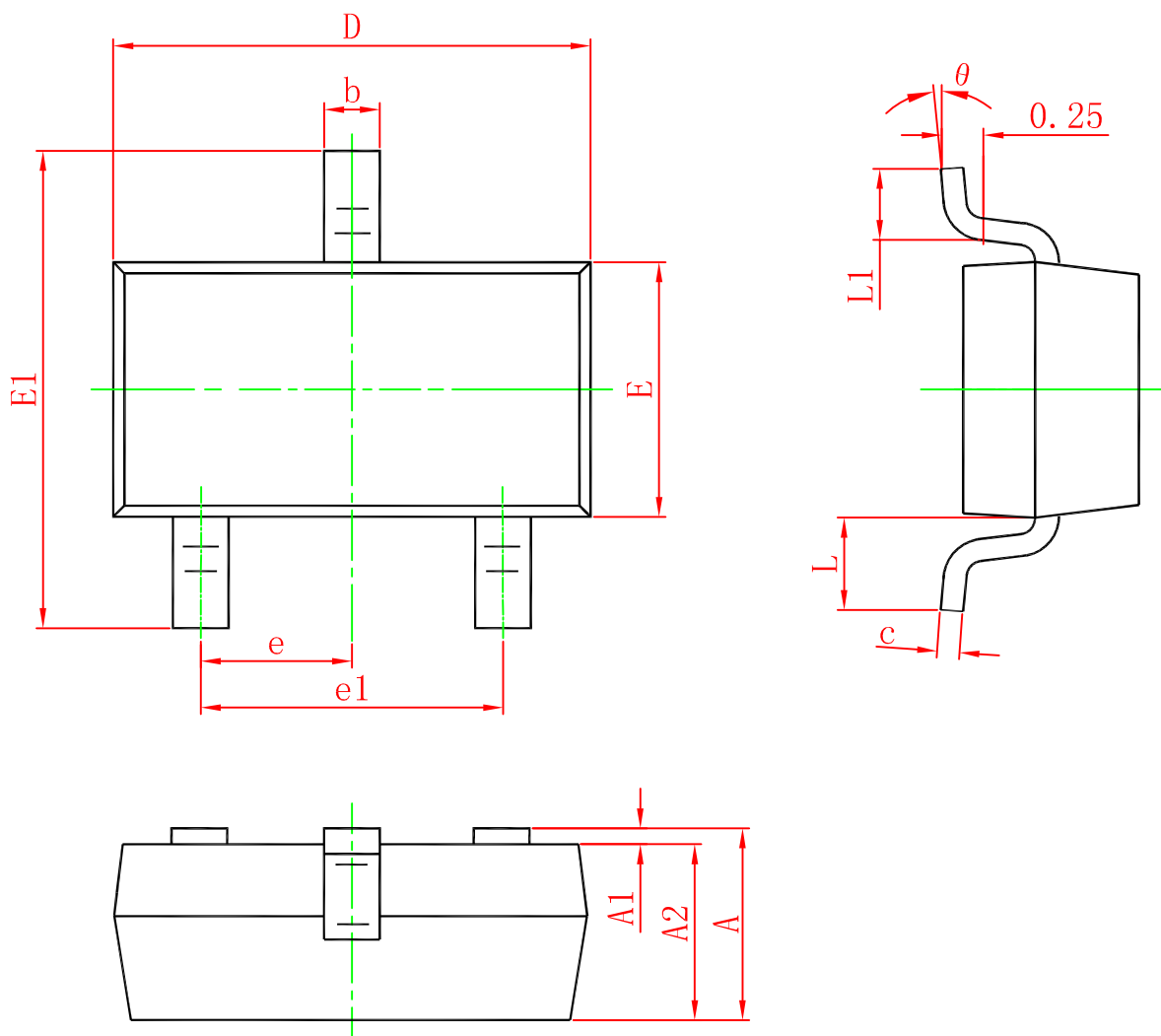

Figure 11: Normalized Maximum Transient Thermal Impedance (Note F)

SOT-23 PACKAGE OUTLINE DIMENSIONS



Symbol	Dimensions In Millimeters		Dimensions In Inches	
	Min.	Max.	Min.	Max.
A	0.900	1.150	0.035	0.045
A1	0.000	0.100	0.000	0.004
A2	0.900	1.050	0.035	0.041
b	0.300	0.500	0.012	0.020
c	0.080	0.150	0.003	0.006
D	2.800	3.000	0.110	0.118
E	1.200	1.400	0.047	0.055
E1	2.250	2.550	0.089	0.100
e	0.950 TYP.		0.037 TYP.	
e1	1.800	2.000	0.071	0.079
L	0.550 REF.		0.022 REF.	
L1	0.300	0.500	0.012	0.020
θ	0°	8°	0°	8°