

The SMDJ series is designed specifically to protect sensitive electronic equipment from voltage transients induced by lightning and other transient voltage events.

#### MECHANICAL DATA

- Case: SMC
- Terminals: Solderable per MIL-STD-750, Method 2026
- Approx. Weight: 0.22g / 0.0077oz

#### FEATURES

- Halogen-Free
- RoHS compliant
- For surface mounted applications in order to optimize board space
- Low profile package
- Built-in strain relief
- Typical maximum temperature coefficient  
 $\Delta VBR = 0.1\% \times VBR@25^{\circ}\text{C} \times \Delta T$
- Glass passivated chip junction
- 3000W peak pulse power capability at IOxIOOOUs waveform, repetition rate {duty cycles}:0.01 %
- Fast response time: typically less than 1.Ops from OV to BV min
- Excellent clamping capability
- Low incremental surge resistance
- Typical IR less than 2UA above 12V
- High Temperature soldering guaranteed: 260°C/40 seconds at terminals
- Plastic package has Underwriters Laboratory Flammability 94V-O
- Matte Tin Lead-free Plated

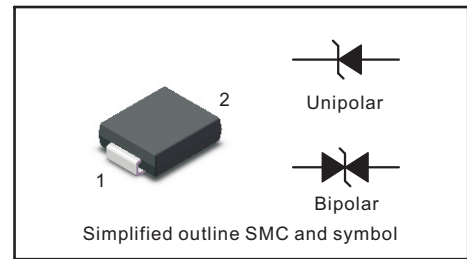

#### Maximum Ratings and Thermal Characteristics (TA=25°C unless otherwise noted)

Parameter	Symbol	Value	Unit
Peak Pulse Power Dissipation at T <sub>A</sub> =25°C by 10x1000 us waveform (Fig.1)(Note 1), (Note 2)	P <sub>PPM</sub>	3000	W
Power Dissipation on infinite heat sink at TA=50°C	P <sub>M(AV)</sub>	6.5	W
Peak Forward Surge Current, 8.3ms Single Half Sine Wave (Note 3)	I <sub>FSM</sub>	300	A
Maximum Instantaneous Forward Voltage at 100A for Unidirectional only	V <sub>F</sub>	3.5	V
Operating Junction and Storage Temperature Range	T <sub>J</sub> T <sub>STG</sub>	-65 to 150	°C
Typical Thermal Resistance Junction to Lead	R <sub>UJL</sub>	15	°C/W
Typical Thermal Resistance Junction to Ambient	R <sub>UJA</sub>	75	°C/W

- Notes:
1. Non-repetitive current pulse . per Fig 3 and derated above Ta = 25°C per Fig. 2
  2. Mounted on copper pad area of 0.31x0.31" (8.0 x 8.0mm) to each terminal
  3. Measured on 8.3ms single half sine wave or equivalent square wave for unidirectional device only, duty cycle=4 per minute maximum

# SMDJ5.0AG THRU SMDJ170AG SMDJ5.0CAG THRU SMDJ170CAG

Characteristics at Ta = 25°C

Table 1

Type		Reverse Stand-off Voltage	Breakdown Voltage		Test Current	Max. Clamp Voltage	Max. Peak Pulse Current	Max. Reverse Leakage	Package	
			V <sub>BR</sub> @ I <sub>T</sub>						SMC	
			UNI	BI	V <sub>RMW</sub>	Min	Max	I <sub>T</sub>	V <sub>C</sub> @ I <sub>PP</sub>	I <sub>PP</sub>
		V	V	V	mA	V	A	µA		
SMDJ5.0AG	SMDJ5.0CAG	5.0	6.4	7	10	9.2	326.1	800	RDE	DDE
SMDJ6.0AG	SMDJ6.0CAG	6.0	6.67	7.37	10	10.3	291.3	800	RDG	DDG
SMDJ6.5AG	SMDJ6.5CAG	6.5	7.22	7.98	10	11.2	267.9	500	RDK	DDK
SMDJ7.0AG	SMDJ7.0CAG	7.0	7.78	8.6	10	12	250	200	PDM	DDM
SMDJ7.5AG	SMDJ7.5CAG	7.5	8.33	9.21	1	12.9	232.6	100	PDP	DDP
SMDJ8.0AG	SMDJ8.0CAG	8.0	8.89	9.83	1	13.6	220.6	50	PDR	DDR
SMDJ8.5AG	SMDJ8.5CAG	8.5	9.44	10.4	1	14.4	208.3	20	PDT	DDT
SMDJ9.0AG	SMDJ9.0CAG	9.0	10	11.1	1	15.4	194.8	10	PDV	DDV
SMDJ10AG	SMDJ10CAG	10.0	11.1	12.3	1	17	176.5	5	PDX	DDX
SMDJ11AG	SMDJ11CAG	11.0	12.2	13.5	1	18.2	164.8	2	PDZ	DDZ
SMDJ12AG	SMDJ12CAG	12.0	13.3	14.7	1	19.9	150.8	2	PEE	DEE
SMDJ13AG	SMDJ13CAG	13.0	14.4	15.9	1	21.5	139.5	2	PEG	DEG
SMDJ14AG	SMDJ14CAG	14.0	15.6	17.2	1	23.2	129.3	2	PEK	DEK
SMDJ15AG	SMDJ15CAG	15.0	16.7	18.5	1	24.4	123	2	PEM	DEM
SMDJ16AG	SMDJ16CAG	16.0	17.8	19.7	1	26	115.4	2	PEP	DEP
SMDJ17AG	SMDJ17CAG	17.0	18.9	20.9	1	27.6	108.7	2	PER	DER
SMDJ18AG	SMDJ18CAG	18.0	20	22.1	1	29.2	102.7	2	PET	DET
SMDJ20AG	SMDJ20CAG	20.0	22.2	24.5	1	32.4	92.6	2	PEV	DEV
SMDJ22AG	SMDJ22CAG	22.0	24.4	26.9	1	35.5	84.5	2	PEX	DEX
SMDJ24AG	SMDJ24CAG	24.0	26.7	29.5	1	38.9	77.1	2	PEZ	DEZ
SMDJ26AG	SMDJ26CAG	26.0	28.9	31.9	1	42.1	71.3	2	PFE	DFE
SMDJ28AG	SMDJ28CAG	28.0	31.1	34.4	1	45.4	66.1	2	PFG	DFG
SMDJ30AG	SMDJ30CAG	30.0	33.3	36.8	1	48.4	62	2	PFK	DFK
SMDJ33AG	SMDJ33CAG	33.0	36.7	40.6	1	53.3	56.3	2	PFM	DFM
SMDJ36AG	SMDJ36CAG	36.0	40	44.2	1	58.1	51.6	2	PFP	DFP
SMDJ40AG	SMDJ40CAG	40.0	44.4	49.1	1	64.5	46.5	2	PFR	DFR
SMDJ43AG	SMDJ43CAG	43.0	47.8	52.8	1	69.4	43.2	2	PFT	DFT
SMDJ45AG	SMDJ45CAG	45.0	50	55.3	1	72.7	41.3	2	PFV	DFV
SMDJ48AG	SMDJ48CAG	48.0	53.3	58.9	1	77.4	38.8	2	PFX	DFX
SMDJ51AG	SMDJ51CAG	51.0	56.7	62.7	1	82.4	36.4	2	PFZ	DFZ
SMDJ54AG	SMDJ54CAG	54.0	60	66.3	1	87.1	34.4	2	RGE	DGE
SMDJ58AG	SMDJ58CAG	58.0	64.4	71.2	1	93.6	32.1	2	PGG	DGG
SMDJ60AG	SMDJ60CAG	60.0	66.7	73.7	1	96.8	31	2	PGK	DGK
SMDJ64AG	SMDJ64CAG	64.0	71.1	78.6	1	103	29.1	2	PGM	DGM
SMDJ70AG	SMDJ70CAG	70.0	77.8	86	1	113	26.5	2	PGP	DGP
SMDJ75AG	SMDJ75CAG	75.0	83.3	92.1	1	121	24.8	2	PGR	DGR
SMDJ78AG	SMDJ78CAG	78.0	86.7	95.8	1	126	23.8	2	PGT	DGT
SMDJ85AG	SMDJ85CAG	85.0	94.4	104	1	137	21.9	2	PGV	DGV
SMDJ90AG	SMDJ90CAG	90.0	100	111	1	146	20.5	2	PGX	DGX
SMDJ100AG	SMDJ100CAG	100.0	111	123	1	162	18.5	2	PGZ	DGZ
SMDJ110AG	SMDJ110CAG	110.0	122	135	1	177	16.9	2	PHE	DHE
SMDJ120AG	SMDJ120CAG	120.0	133	147	1	193	15.5	2	PHG	DHG
SMDJ130AG	SMDJ130CAG	130.0	144	159	1	209	14.4	2	PHK	DHK
SMDJ150AG	SMDJ150CAG	150.0	167	185	1	243	12.3	2	PHM	DHM
SMDJ160AG	SMDJ160CAG	160.0	178	197	1	259	11.6	2	PHP	DHP
SMDJ170AG	SMDJ170CAG	170.0	189	209	1	275	10.9	2	PHR	DHR

Fig.1 Peak Pulse Power Rating Curve

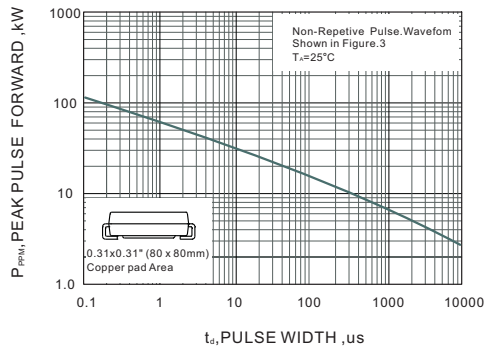

Fig.2 Forward Current Derating Curve

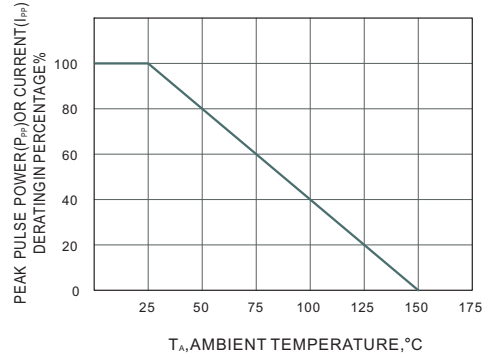

Fig.3 Pulse Waveform

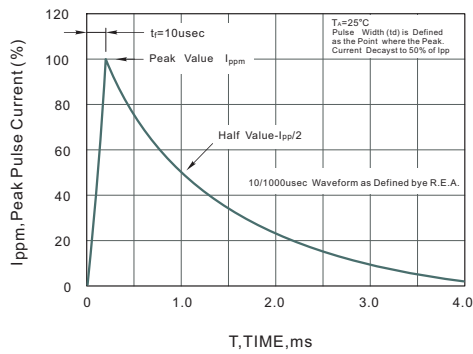

Fig.4 Typical Junction Capacitance

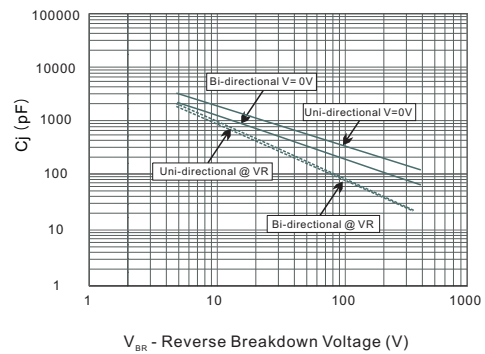

Fig.5 Steady State Power Derating Curve

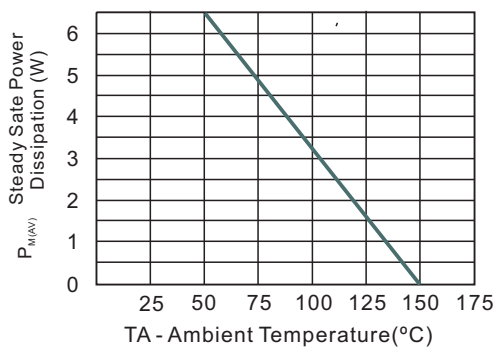
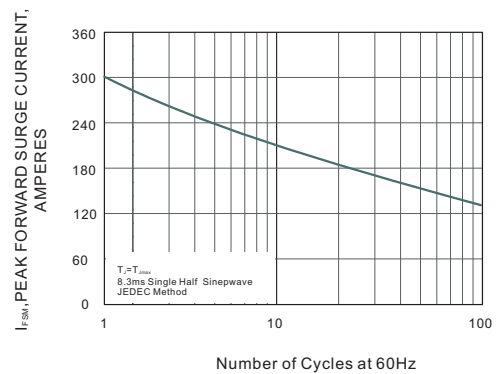

Fig.6 Maximum Non-Repetitive Peak Forward Surge Current



**PACKAGE OUTLINE**

Plastic surface mounted package; 2 leads

SMC

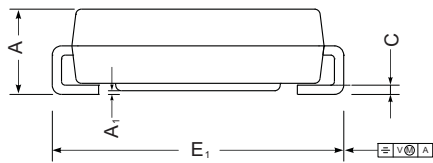
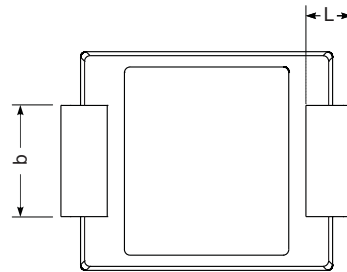
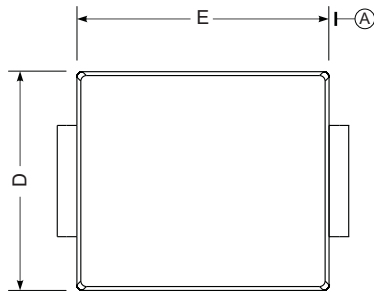

SMC mechanical data

UNIT		A	E	D	E <sub>1</sub>	A <sub>1</sub>	C	L	b
mm	max	2.62	7.1	6.2	8.1	0.21	0.31	1.7	3.25
	min	2.00	6.6	5.6	7.8	0.05	0.15	1.0	2.75
mil	max	103	280	244	319	8.3	12	59	128
	min	79	260	220	307	2.0	5.9	32	108

**The recommended mounting pad size**

