

## Silicon Bidirectional Trigger Diodes

### FEATURES

These diacs are intended for use in thyristor phase control circuits for lamp-dimming, universal-motor speed controls, and heat controls.

### MECHANICAL DATA

Case: SOD-123

Terminals: Solderable per MIL-STD-750, Method 2026

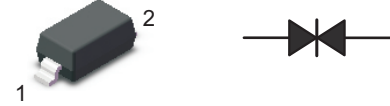

Top View

Simplified outline SOD-123 and symbol

### Absolute Maximum Ratings (Ta = 25°C)

Parameter	Symbol	Value	Unit
Power Dissipation (T <sub>c</sub> = 100°C)	P <sub>tot</sub>	150	mW
Repetitive Peak On-state Current (t <sub>p</sub> = 20 μs, f = 100 Hz)	I <sub>TRM</sub>	2	A
Operating Junction and Storage Temperature Range	T <sub>j</sub> , T <sub>stg</sub>	- 40 to + 125	°C

### Characteristics at Ta = 25°C

Parameter		Symbol	Min.	Max.	Unit
Breakover Voltage at C = 22 nF, see diagram 1	DB3T	V <sub>BO</sub>	28	36	V
	DC34T		30	38	V
	DB4T		35	45	V
Breakover Voltage Symmetry at C = 22 nF, see diagram 1		[ +V <sub>BO</sub>   -  -V <sub>BO</sub>  ]	—	3	V
Dynamic Breakover Voltage at ΔI = [I <sub>BO</sub> to I <sub>F</sub> = 10 mA]		ΔV <sub>±</sub>	5	—	V
Output Voltage See diagram 2		V <sub>O</sub>	5	—	V
Breakover Current at C = 22 nF		I <sub>BO</sub>	—	50	μA
Leakage Current at V <sub>B</sub> = 0.5V <sub>BOmax</sub>		I <sub>B</sub>	—	10	μA
Rise Time See diagram 3		t <sub>r</sub>	—	2	μs

Diagram1: current-voltage characteristic

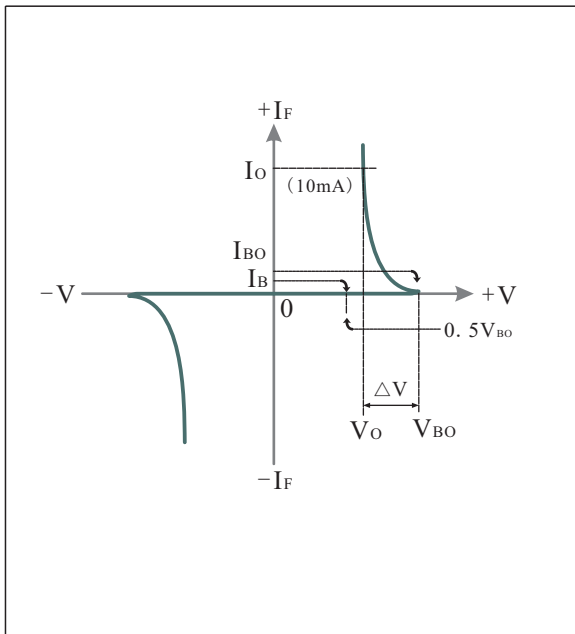

Diagram2: Test circuit for output voltage

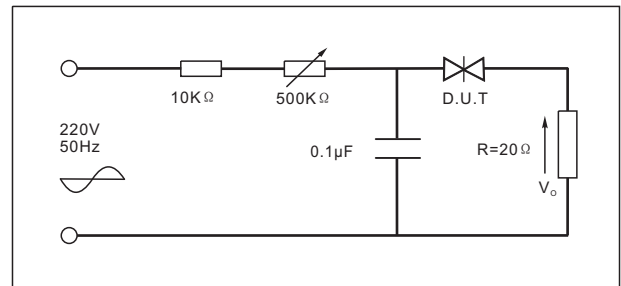

Diagram3: Test circuit see Fig.2. Adjust R for  $I_p=0.5A$

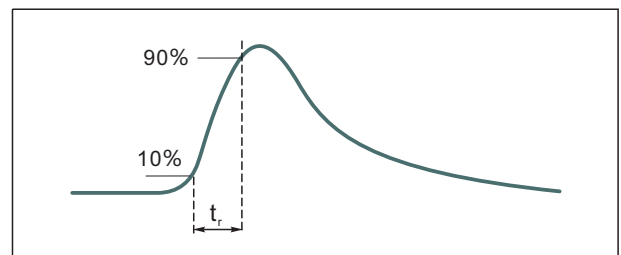

Fig.1: Power dissipation versus ambient temperature(maximum values)

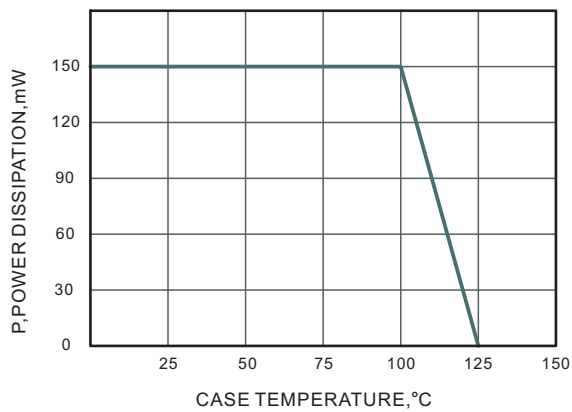

Fig.2: Power dissipation versus ambient temperature(maximum values)

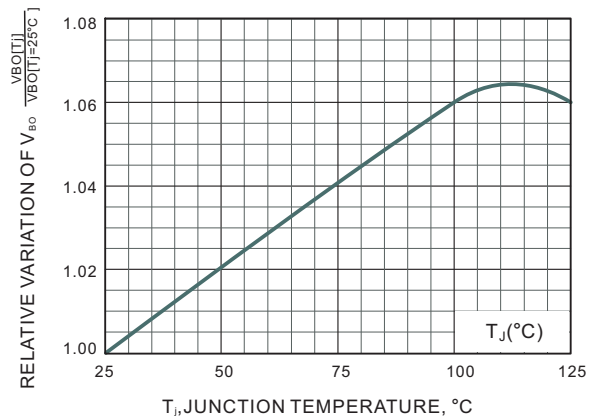
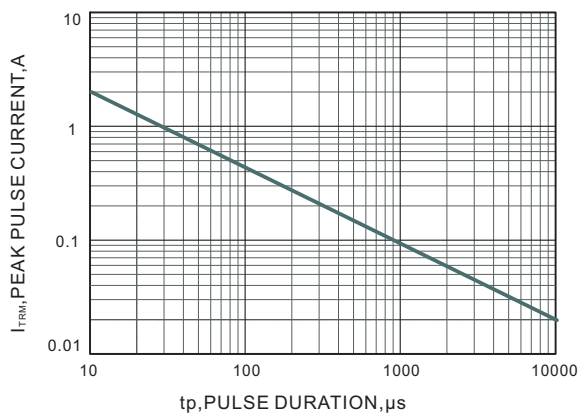

Fig.3: Power dissipation versus ambient temperature(maximum values)



## PACKAGE OUTLINE

Plastic surface mounted package; 2 leads

SOD-123

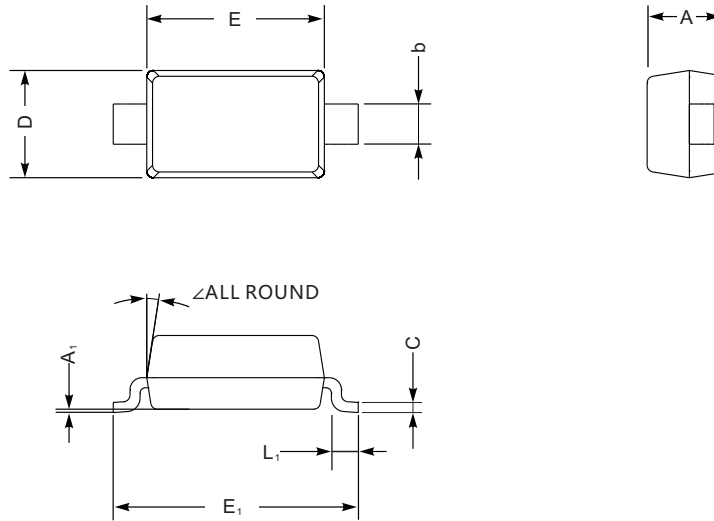

SOD-123 mechanical data

UNIT		A	C	D	E	E <sub>1</sub>	L <sub>1</sub>	b	A <sub>1</sub>	∠
mm	max	1.3	0.22	1.8	2.8	3.9	0.45	0.7	0.2	9°
	min	0.9	0.09	1.5	2.5	3.6	0.25	0.5	—	
mil	max	51	8.7	71	110	154	18	28	8	
	min	35	3.5	59	98	142	10	20	—	

### The recommended mounting pad size

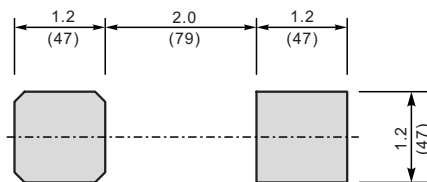

Unit:  $\frac{\text{mm}}{\text{(mil)}}$

### Marking

Type number	Marking code
DB3T	DB3
DC34T	DC34
DB4T	DB4