

Surface Mount Ultrafast Recovery Rectifier

Reverse Voltage – 50V~1000 V Forward Current – 3.0 A

PINNING

PIN	DESCRIPTION
1	Cathode
2	Anode

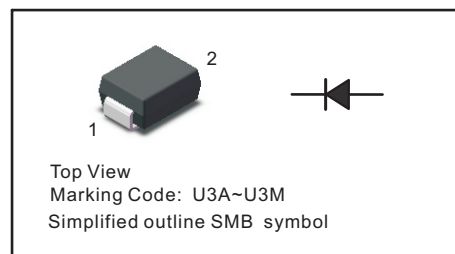

FEATURES

- For surface mounted applications
- Low profile package
- Glass Passivated Chip Junction
- Easy to pick and place
- High efficiency
- Lead free in comply with EU RoHS 2011/65/EU directives

MECHANICAL DATA

- Case: SMB
- Terminals: Solderable per MIL-STD-750, Method 2026
- Approx. Weight: 0.055g / 0.002oz

Maximum Ratings and Electrical characteristics

Ratings at 25 °C ambient temperature unless otherwise specified.

Single phase half-wave 60 Hz, resistive or inductive load, for capacitive load current derate by 20 %.

Parameter	Symbols	US3AB G	US3BB G	US3DB G	US3GB G	US3JB G	US3KB G	US3MB G	Units
Maximum Repetitive Peak Reverse Voltage	V_{RRM}	50	100	200	400	600	800	1000	V
Maximum RMS voltage	V_{RMS}	35	70	140	280	420	560	700	V
Maximum DC Blocking Voltage	V_{DC}	50	100	200	400	600	800	1000	V
Maximum Average Forward Rectified Current	$I_{F(AV)}$	3							A
Peak Forward Surge Current 8.3 ms Single Half Sine Wave Superimposed on Rated Load	I_{FSM}	90							A
Maximum Instantaneous Forward Voltage at 3 A	V_F	1.0		1.3		1.68			V
Maximum DC Reverse Current $T_a = 25\text{ }^\circ\text{C}$ at Rated DC Blocking Voltage $T_a = 125\text{ }^\circ\text{C}$	I_R	5 100							μA
Maximum Reverse Recovery Time ⁽¹⁾	t_{rr}	50				75			ns
Typical Thermal Resistance ⁽²⁾	$R_{\theta JA}$ $R_{\theta JC}$	45 15							$^\circ\text{C/W}$
Operating and Storage Temperature Range	T_j, T_{stg}	-55 ~ +150							$^\circ\text{C}$

(1) Measured with $I_F = 0.5\text{ A}$, $I_R = 1\text{ A}$, $I_{rr} = 0.25\text{ A}$.

(2) P.C.B. mounted with 2.0" X 2.0" (5 X 5 cm) copper pad areas.

Fig.1 Maximum Average Forward Current Rating

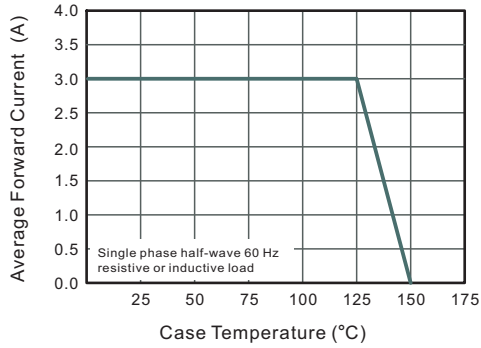

Fig.2 Typical Reverse Characteristics

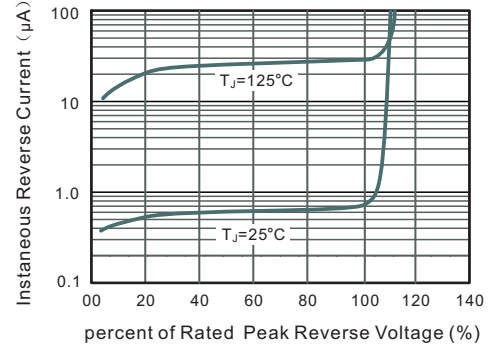

Fig.3 Typical Forward Characteristics

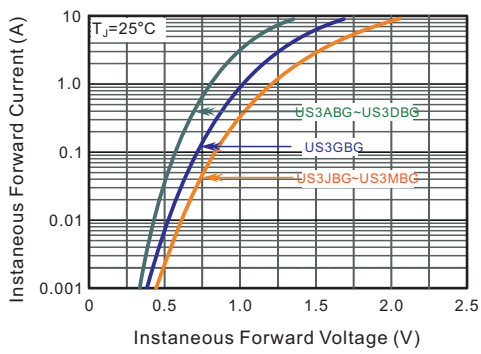
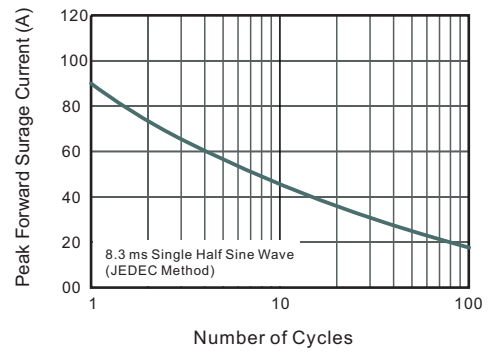

Fig.4 Maximum Non-Repetitive Peak Forward Surge Current



PACKAGE OUTLINE

Plastic surface mounted package; 2 leads

SMB

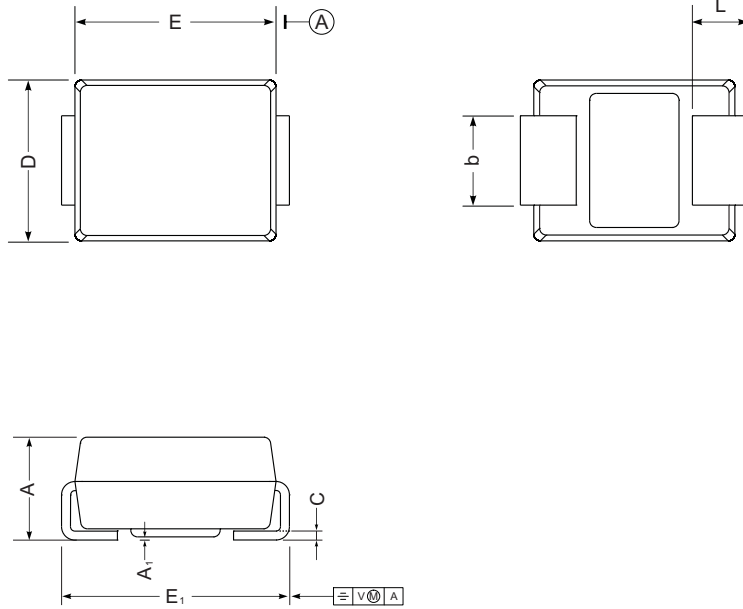

SMB mechanical data

UNIT		A	E	D	E ₁	A ₁	L	C	b
mm	max	2.44	4.70	3.94	5.59	0.20	1.5	0.305	2.2
	min	2.13	4.06	3.3	5.08	0.05	0.8	0.152	1.9
mil	max	96	185	155	220	7.9	59	12	87
	min	84	160	130	200	2.0	32	6	75

The recommended mounting pad size

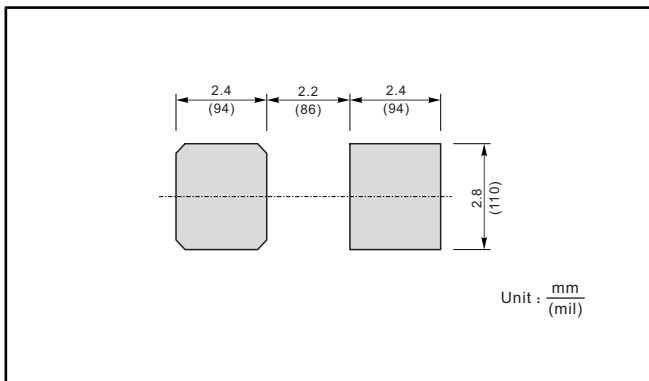

Marking

Type number	Marking code
US3ABG	US3A
US3BBG	US3B
US3DBG	US3D
US3GBG	US3G
US3JBG	US3J
US3KBG	US3K
US3MBG	US3M