

## SURFACE MOUNT ULTRAFAST RECOVERY RECTIFIER

Reverse Voltage - 50 to 1000 V Forward Current - 1 A

### PINNING

PIN	DESCRIPTION
1	Cathode
2	Anode

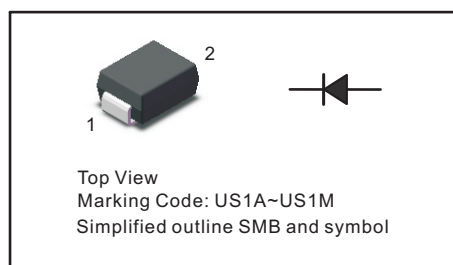

### FEATURES

- For surface mounted applications
- Low profile package
- Glass Passivated Chip Junction
- Easy to pick and place
- High efficiency
- Lead free in comply with EU RoHS 2011/65/EU directives

### MECHANICAL DATA

- Case: SMB
- Terminals: Solderable per MIL-STD-750, Method 2026
- Approx. Weight: 0.055g / 0.002oz

### Maximum Ratings and Electrical characteristics

Ratings at 25 °C ambient temperature unless otherwise specified.

Single phase half-wave 60 Hz, resistive or inductive load, for capacitive load current derate by 20 %.

Parameter	Symbols	US1AB G	US1BB G	US1DB G	US1GB G	US1JB G	US1KB G	US1MB G	Units
Maximum Repetitive Peak Reverse Voltage	$V_{RRM}$	50	100	200	400	600	800	1000	V
Maximum RMS voltage	$V_{RMS}$	35	70	140	280	420	560	700	V
Maximum DC Blocking Voltage	$V_{DC}$	50	100	200	400	600	800	1000	V
Maximum Average Forward Rectified Current at $T_c = 125\text{ }^\circ\text{C}$	$I_{F(AV)}$	1							A
Peak Forward Surge Current 8.3 ms Single Half Sine Wave Superimposed on Rated Load	$I_{FSM}$	30							A
Maximum Instantaneous Forward Voltage at 1 A	$V_F$	1.0		1.3		1.65		V	
Maximum DC Reverse Current $T_a = 25\text{ }^\circ\text{C}$ at Rated DC Blocking Voltage $T_a = 125\text{ }^\circ\text{C}$	$I_R$	5 100							$\mu\text{A}$
Maximum Reverse Recovery Time <sup>(1)</sup>	$t_{rr}$	50				75			ns
Typical Thermal Resistance <sup>(2)</sup>	$R_{\theta JA}$	75							$^\circ\text{C/W}$
Operating and Storage Temperature Range	$T_j, T_{stg}$	-55 ~ +150							$^\circ\text{C}$

(1) Measured with  $I_F = 0.5\text{ A}$ ,  $I_R = 1\text{ A}$ ,  $I_{rr} = 0.25\text{ A}$ .

(2) P.C.B. mounted with 2.0" X 2.0" (5 X 5 cm) copper pad areas.

**Fig.1 Forward Current Derating Curve**

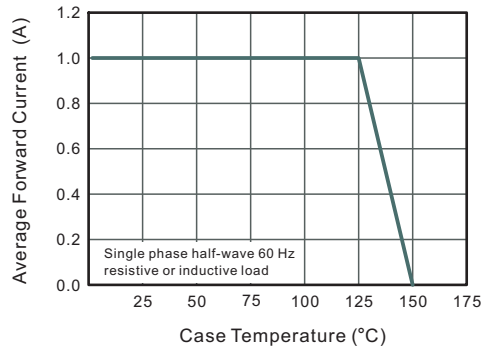

**Fig.2 Typical Reverse Characteristics**

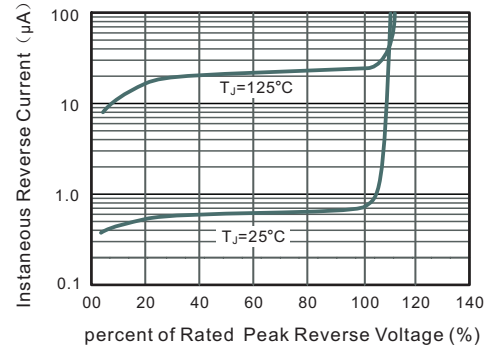

**Fig.3 Typical Forward Characteristics**

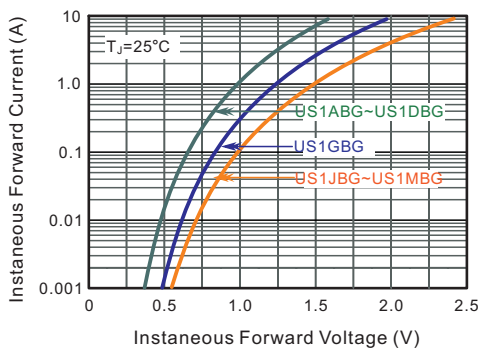

**Fig.4 Maximum Non-Repetitive Peak Forward Surge Current**

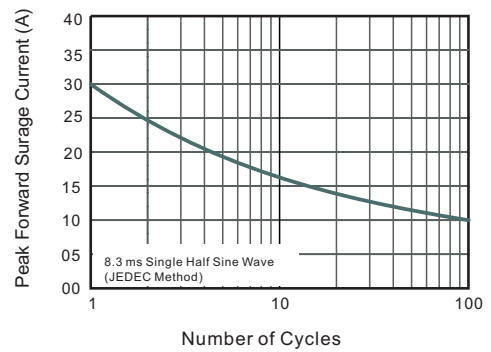

## PACKAGE OUTLINE

Plastic surface mounted package; 2 leads

SMB

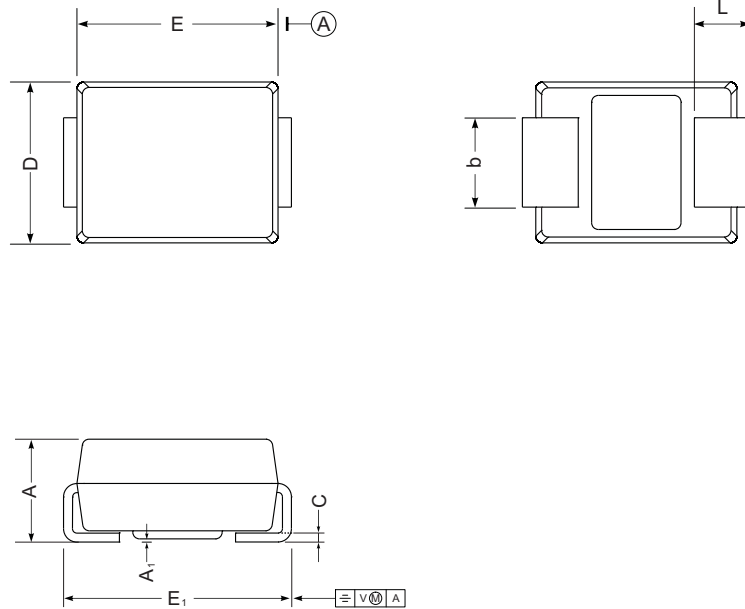

SMB mechanical data

UNIT		A	E	D	E <sub>1</sub>	A <sub>1</sub>	L	C	b
mm	max	2.44	4.70	3.94	5.59	0.20	1.5	0.305	2.2
	min	2.13	4.06	3.3	5.08	0.05	0.8	0.152	1.9
mil	max	96	185	155	220	7.9	59	12	87
	min	84	160	130	200	2.0	32	6	75

### The recommended mounting pad size

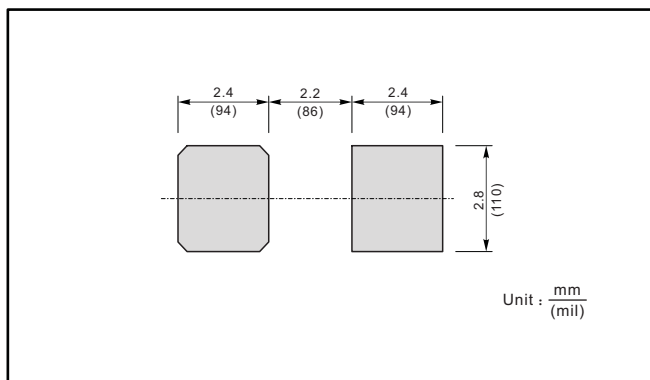

### Marking

Type number	Marking code
US1ABG	US1A
US1BBG	US1B
US1DBG	US1D
US1GBG	US1G
US1JBG	US1J
US1KBG	US1K
US1MBG	US1M